

RND PRECISION IMAGING

We do 3D!

We can do all your CAD and 3D laser scanning work! Utilizing both laser and white light scanners PLUS our expert team of scan resurfacing including CAD engineers; **our goal is to help you save time and money and at the same time provide the best quality product...**

"I have used RnD Precision Imaging to great advantage in rapidly reproducing complex parts. As well as being highly experienced, I have found RnD to be very proactive and productive and do not hesitate to recommend their services." Jon Spalding, Composite Care Baths

"Excellent work, thanks!" Cameron Shiyuk, Pacific Coast Marine Windshields Ltd.

At RnD Precision Imaging Inc, we are a "yes-we-can" company. Tell us your problem and we'll do everything we can to help with a solution. We are great project managers and are happy to perform large-scale service projects in addition to smaller projects. So whether you need simple STL data for 1 part, or class A surfaces of 500 parts, give us a call!

Using our 3D scanners and CAD service will help YOU:

- Measure parts accurately
- Obtain immediate results
- Visualize the finished product
- Minimize capital expenditures
- Stay focused on your core business
- Not be tied to a specific 3D scanning technology
- Have parts scanned on or off-site
- Quickly compare as-built to as-designed
- Find and fix manufacturing defects
- Rapid prototype efficiently
- Scale parts up or down
- Save warehouse space
- Create CAD models that reflect actual parts or models
- Analyze the competition
- Increase efficiency and Improve Quality

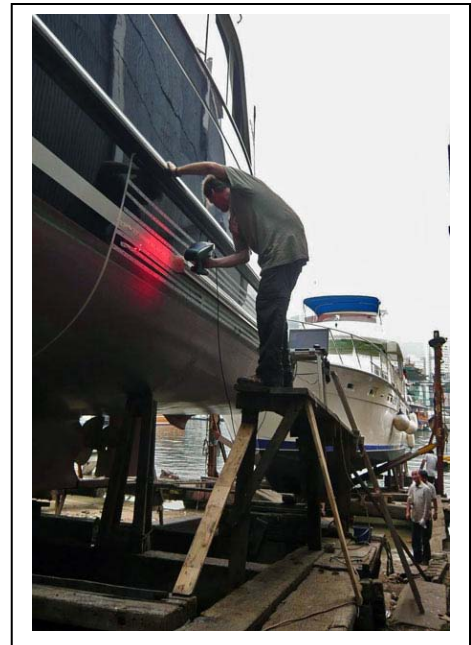

Whether its scanning for visualization, such as a priceless artifact at a museum, gaming or medical applications, to larger projects involving reverse engineering such as designing a boat hull or aircraft components, we can assist you in getting it done on time and on (or below) budget!

RnD Precision Imaging Inc
Vancouver, BC Toronto, ON
1-888-623-4462

Does Size Matter?

Not for our 3D scanning or CAD service! We can do all your 3D scanning & CAD work!

No matter the size of your object or how many you have, RnD Precision Imaging Inc can help you dramatically increase your productivity and efficiency. Realize the immediate benefits of CAD team or our 3D scanning has to offer today!

Here are just a few of the projects we have worked on...

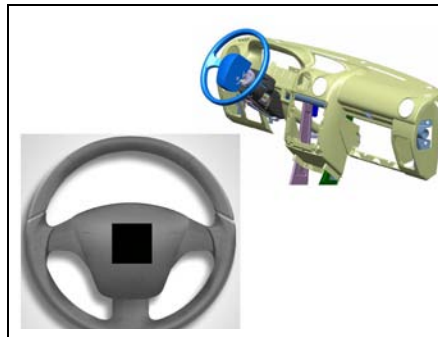
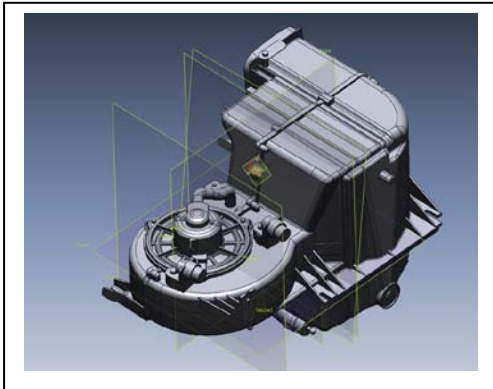
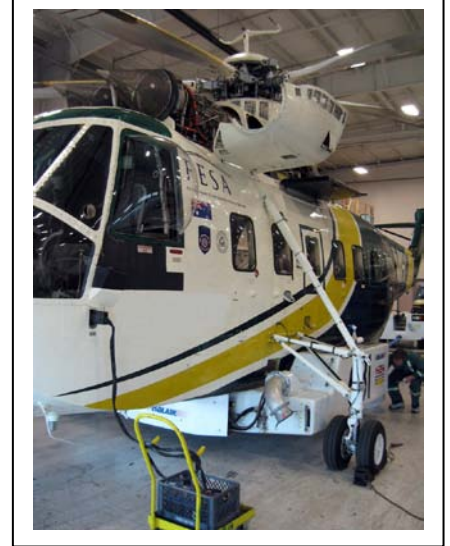
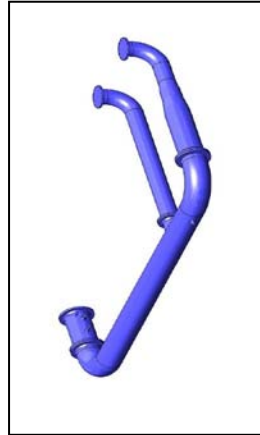
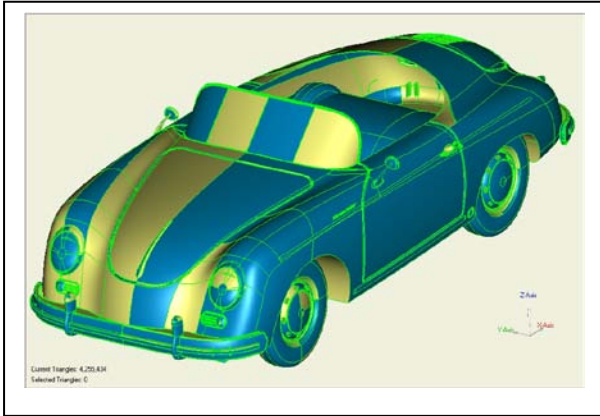

From cars, boats, aircraft, movie props, medical projects, priceless artifacts, dental implants, and mechanical parts, our 3D scanning and CAD service provides you with high quality digital models - no matter how big or small your part is.

Our greatest strength is fitting seamlessly within your work flow to minimize cost and maximize efficiency. No matter what project you are doing, whatever software suite you use or need, we use it too! Here are some of the software suites we use:

SolidWorks, Rapidform, Geomagic, Metris Focus, Pro/E, CATIA, Photomodeler, ProE, Unigraphics, Rhino, ICEM, Ideas, 3D Studio Max, Imageware and more...

Our accuracy analysis ensures your projects are within the exacting specs you demand. You can be confident with the results.

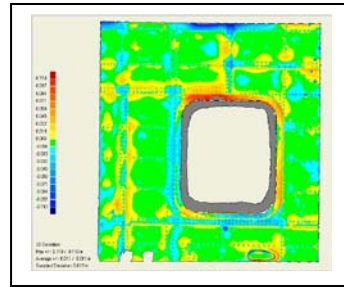

**We strive to deliver "better than satisfactory" results for every client we work with!
We Are Results Oriented Problem Solvers!**

Don't let us be the judge. Word of mouth is extremely important to us...

"RnD Precision Imaging worked hard to accommodate our demanding timeline while maintaining the high quality necessary for Aerospace applications. RnD was very helpful, and we highly recommend them to anyone requiring CAD or scanning services." Steve Bruce, VIH Aerospace

"The file looks fantastic and it seems to be a perfect match. The Client is very happy with it and that's what's most important. Thank you very much for your effort and for getting this done as quickly as you did." Kurt Roberts, Formashape

"The Mech R&D team was impressed with the quality of work and the overall timing on getting the scan completed." Valentin Pantea, Siemens

Some previous clients...

SIEMENS



A VIH Aviation Group Company



**View some 3D examples of our work below.
(Requires Adobe Pdf Reader 7.0 or higher)**

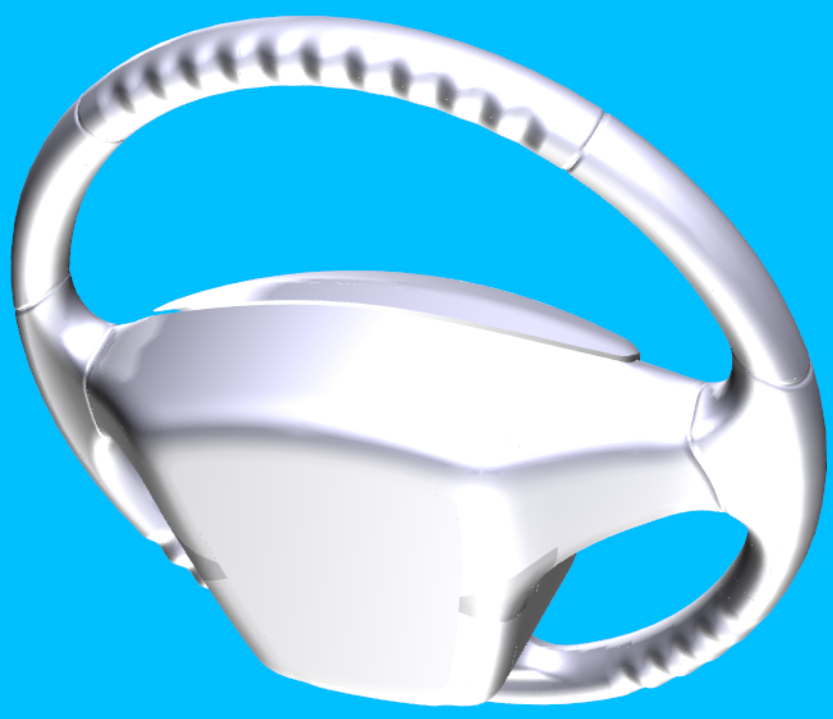

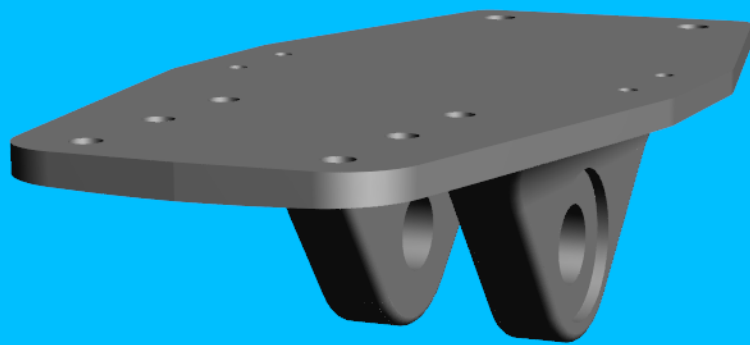

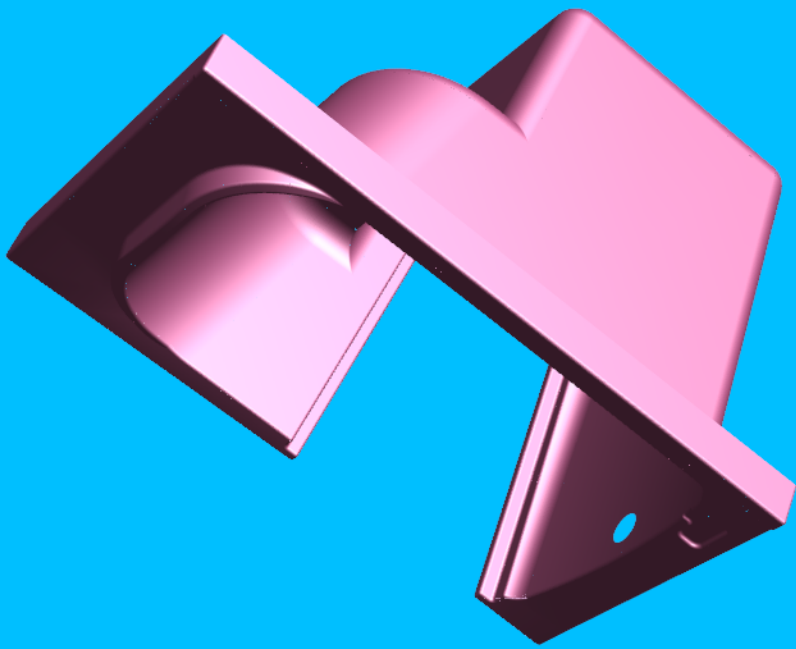

Call us today to start your 3D scanning and CAD projects.

Vancouver Office

110-2161 West 12th Ave.
Vancouver, BC
V6K-4S7

Toronto Office

80 Power Street
Toronto, ON
M5A 3A7

Toll free: 1-888-623-4462

mobile: 1-778-882-4440

Ron@rndprecisionimaging.com

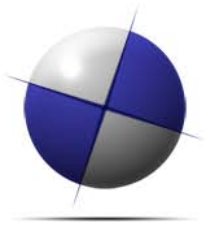

RND PRECISION IMAGING